

DRY-WELL SEWAGE LIFTING STATION

TYPE: ESS 200/2/3.0/3400/P/3000PE



Technical parameters:

- Sump diameter $\varnothing 3000$ mm
- Retention module Stal 1.4307
- Active retention volume 3400 dm^3
- Max. inflow $Q_{\text{max}} = 200 \text{ m}^3/\text{h}$
- Piping diameter DN200
- Inflow connection diameter DN400
- Transport width 3810 mm

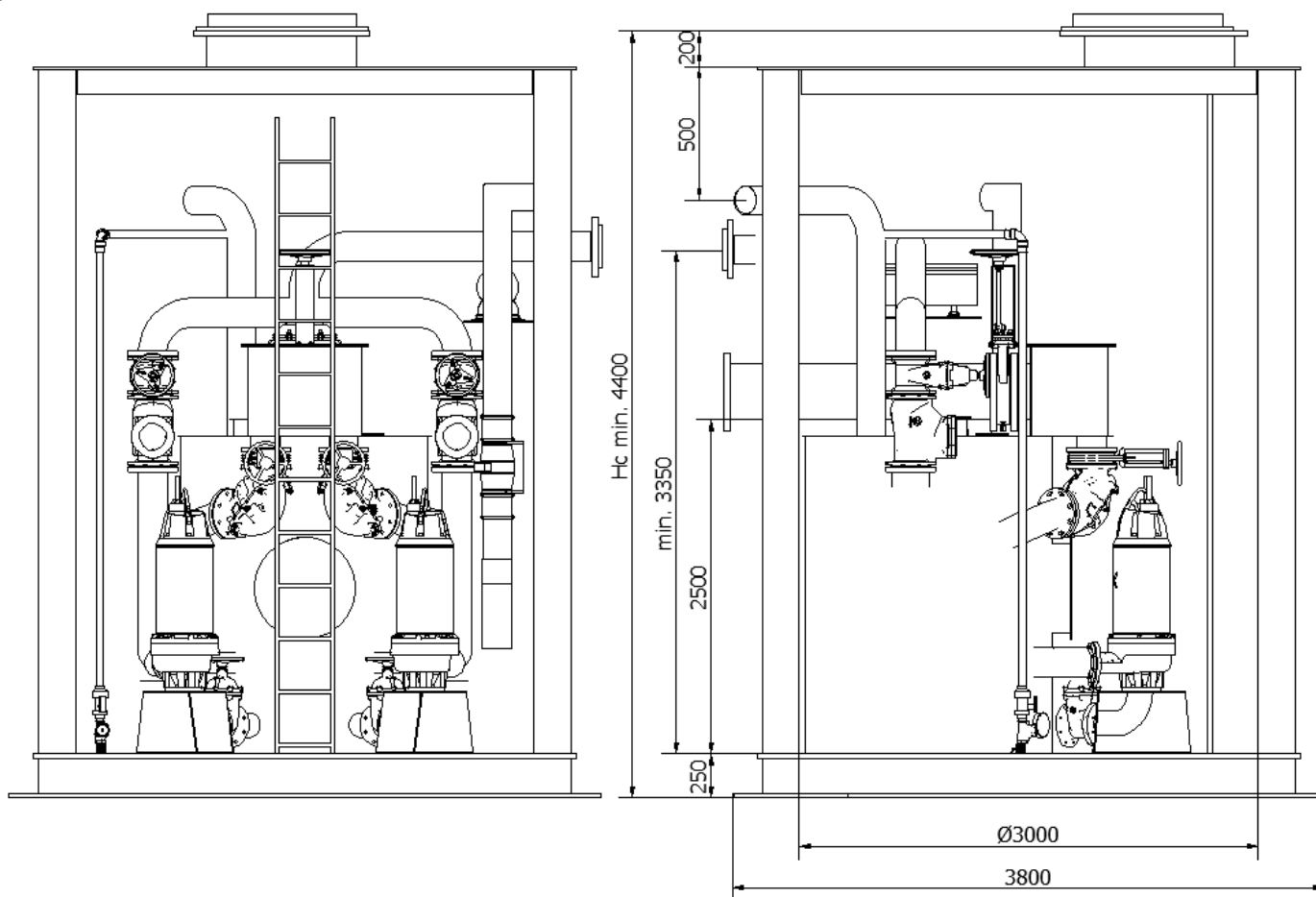
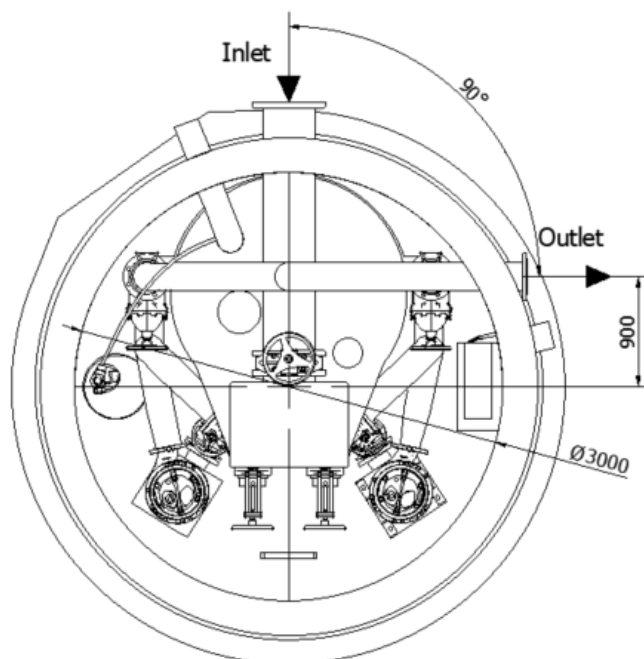

DRY-WELL SEWAGE LIFTING STATION

TYPE: ESS 200/2/3.0/3400/P/3000PE

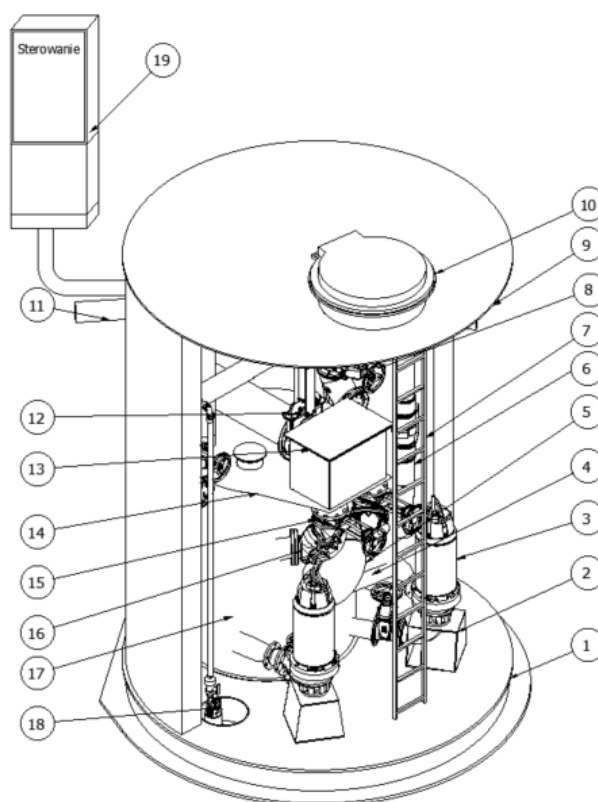

Lo.	Name	Qty	Material
1	Bottom	1	HDPE
2	Pump mounting elbow	2	Cast iron/St. steel 1.4307
3	Pump	2	Cast iron
4	Inflow by-pass	2	St. steel 1.4307
5	Inspection hatch for the retention tank	1	St. steel 1.4307
6	Mechanical ventilation of the chamber	1	St. steel 1.4307
7	CE marked ladder with a retractable handrail	1	HDPE
8	By-pass power system with a nair preparation station	1	St. steel 1.4307
9	Cover	1	HDPE
10	Manhole cover	1	Cast iron/St. steel 1.4307
11	PE 110/160 ventilation of the module with an odour neutralizer	1	HDPE/Activated carbon
12	Shut-off gate valve on inlet	1	Cast iron
13	Manifold and overflow system	1	St. steel 1.4307
14	Retention module	1	St. steel 1.4307
15	Shut-off gate valve on inlet	2	Cast iron
16	Automatic shut-off system	2	Cast iron
17	Solid particle separator	2	St. steel 1.4307
18	Chamber drainage system	1	HDPE/Cast iron
19	Controls	1	