

DRY-WELL SEWAGE LIFTING STATION MODULE TYPE: ETS II 100/2/2.0/700 M



Technical parameters:

- Sump diameter $\varnothing 2000$ mm
- Retention module Steel 1.4307
- Active retention volume 700 dm³
- Max inflow $Q_{\max} = 40$ m³/h
- Piping diameter DN100
- Inflow connection diameter DN250
- Module weight 950 kg (*)

(*) - without pumps

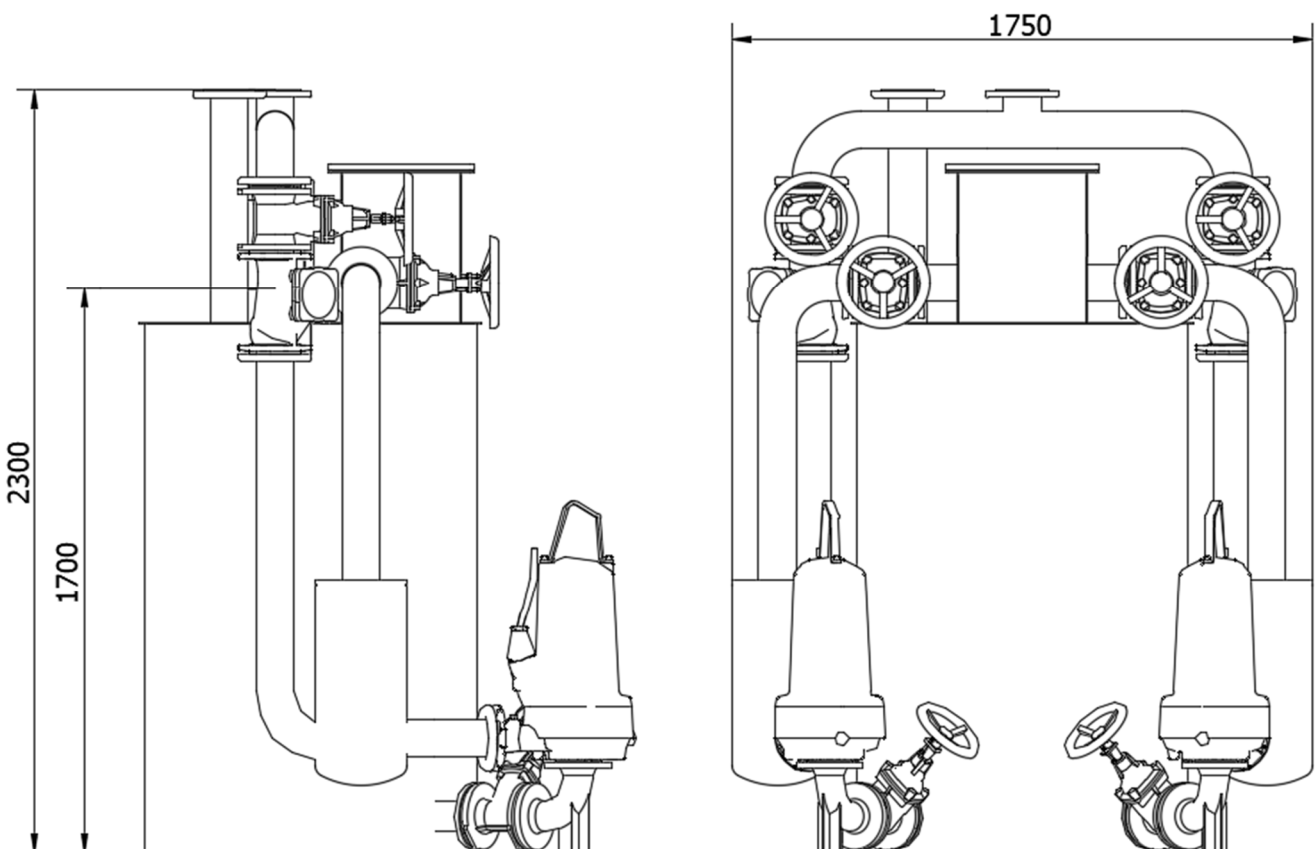
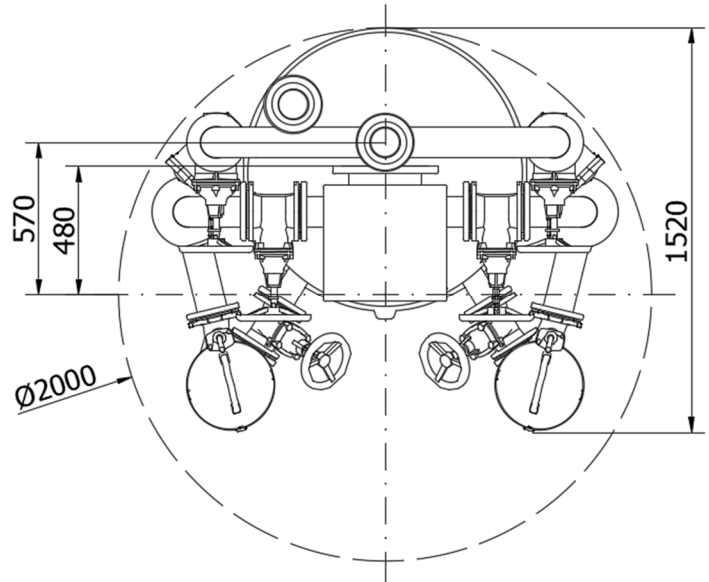

DRY-WELL SEWAGE LIFTING STATION MODULE TYPE: ETS II 100/2/2.0/700 M

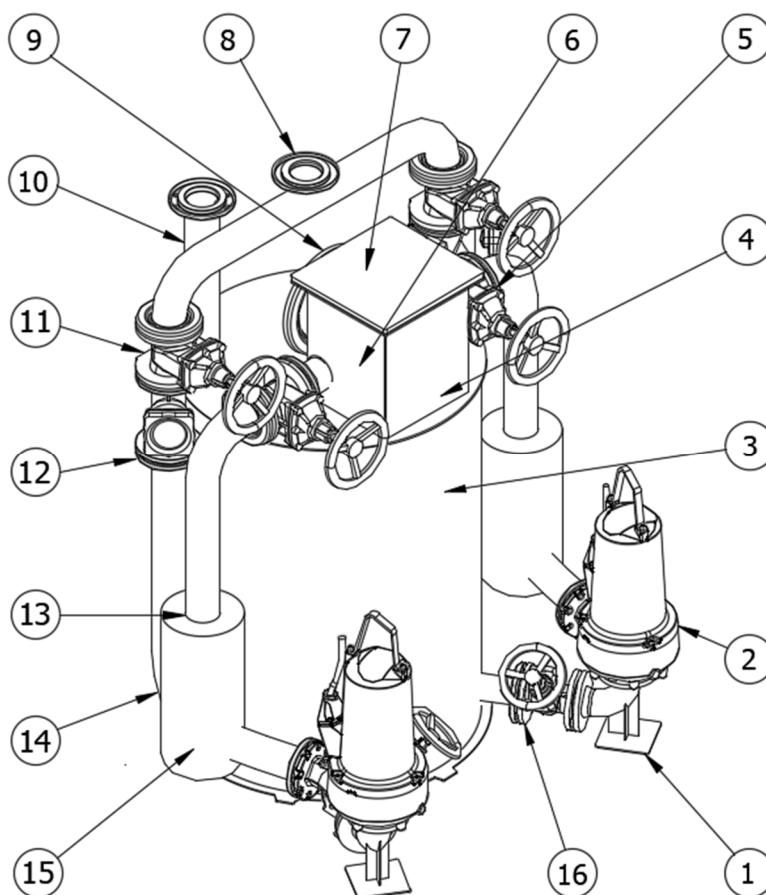

No.	Name	Qty	Material
1	Pump mounting elbow	2	Cast iron/St. steel 1.4307
2	Pump	2	Cast iron
3	Retention tank	1	Steel 1.4307
4	Hydrostatic probe mount with cable gland	1	Steel 1.4307
5	Soft-sealed gate valve on inflow DN100	2	Cast iron
6	Manifold with overflow system	1	Steel 1.4307/HDPE
7	Inspection hatch for the retention tank	1	Steel 1.4307
8	Module flange connection DN100	1	Steel 1.4307
9	Flange connection for gravity flow DN250	1	Steel 1.4307
10	Ventilation of the lifting station module DN100	1	Steel 1.4307
11	Soft-sealed gate valve on the discharge pipe DN100	2	Cast iron
12	Straight ball check valve on the discharge pipe DN100	2	Cast iron
13	Automatic shut-off of the inflow DN100	2	Cast iron
14	Piping DN100	2	St. steel 1.4307
15	Solids separator	2	St. steel 1.4307
16	Soft-sealed gate valve	2	Cast iron

(**) - pumps not included in the standard scope of delivery